

INN100W070A

100V Enhancement-mode GaN Power Transistor

INN100W070A

1. General description

GaN-on-Silicon enhancement mode high-electron-mobility-transistor (HEMT) in Solder Bar WLCSP with 2.50 mm x 1.50 mm package size.

2. Features

- GaN-on-Silicon E-mode HEMT technology
- Very low gate charge
- Ultra-low on resistance
- Very small package size
- Zero reverse recovery charge

3. Applications

- Synchronous rectification
- Class-D audio
- High frequency DC-DC converter
- Communication base station
- Motor driver

4. Key performance parameters

Table 1 Key performance parameters at $T_J = 25\text{ }^\circ\text{C}$

Parameter	Value	Unit
$V_{DS,max}$	100	V
$R_{DS(on),max}$ @ $V_{GS} = 5\text{ V}$	7	m Ω
$Q_{G,typ}$ @ $V_{DS} = 50\text{ V}$	4.5	nC
$I_{DS,Pulse}$	125	A
Q_{OSS} @ $V_{DS} = 50\text{ V}$	25	nC

5. Pin information

Table 2 Pin information

PIN	Pin Description	Pin Function
2,4,6	Source	Power Source
3,5	Drain	Power Drain
1	Gate	Driver Gate

Table 3 Ordering information

Type/Ordering Code	Package	Product Code
INN100W070A	WLCSP 2.50x1.50	J17

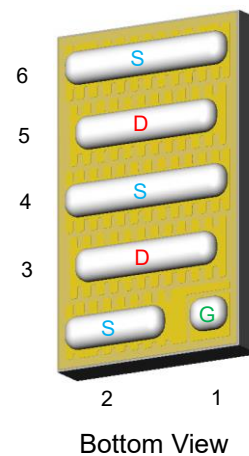
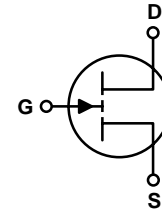

Bottom View

Table of contents

1. General description	1
2. Features.....	1
3. Applications	1
4. Key performance parameters.....	1
5. Pin information.....	1
6. Maximum ratings	3
7. Thermal characteristics.....	4
8. Electric characteristics.....	5
9. Electric characteristics diagrams	7
10.Package outlines.....	12
11.Reel information.....	13
12.Land Pattern.....	14
13.Revision history.....	15

6. Maximum ratings

at $T_J = 25\text{ }^\circ\text{C}$ unless otherwise specified.

Continuous application of maximum ratings can deteriorate transistor lifetime. For further information, contact Innoscience sales office.

Table 4 Maximum ratings

SYMBOL	PARAMETER	MAX	UNIT
V_{DS}	Drain-to-Source Voltage (Continuous)	100	V
I_D	Continuous current	29	A
	Pulsed ($25\text{ }^\circ\text{C}$, $T_{Pulse} = 100\ \mu\text{s}$)	125	A
V_{GS}	Gate-to-Source Voltage	6	V
	Gate-to-Source Voltage	-4	V
T_J	Operating Temperature	-40 to 150	$^\circ\text{C}$
T_{STG}	Storage Temperature	-40 to 150	$^\circ\text{C}$

7. Thermal characteristics

Table 5 Thermal characteristics

SYMBOL	PARAMETER	TYP	UNIT
$R_{\theta JC}$	Thermal Resistance, Junction to Case	0.62	$^{\circ}C/W$
$R_{\theta JB}$	Thermal Resistance, Junction to Board	1.98	$^{\circ}C/W$
$R_{\theta JA}$	Thermal Resistance, Junction to Ambient ¹	62.76	$^{\circ}C/W$

Note 1: $R_{\theta JA}$ is determined with the device mounted on one square inch of copper pad, single layer 2 oz copper on FR4 board.

8. Electric characteristics

at $T_J = 25\text{ }^\circ\text{C}$ unless otherwise specified.

Table 6 Static characteristics

SYMBOL	PARAMETER	MIN	TYP	MAX	UNIT	TEST CONDITIONS
BV_{DSS}	Drain-to-Source Voltage	100	-	-	V	$V_{GS} = 0\text{ V}$, $I_D = 600\text{ }\mu\text{A}$
I_{DSS}	Drain Source Leakage	-	1.5	14	μA	$V_{GS} = 0\text{ V}$, $V_{DS} = 80\text{ V}$
I_{GSS}	Gate-to-Source Forward Leakage(25°C)	-	1	15	μA	$V_{GS} = 5\text{ V}$
	Gate-to-Source Forward Leakage(125°C)	-	50	1000	μA	$V_{GS} = 5\text{ V}$
	Gate-to-Source Reverse Leakage	-	0.1	0.5	μA	$V_{GS} = -4\text{ V}$
$V_{GS(TH)}$	Gate Threshold Voltage	0.8	1.1	2.5	V	$V_{DS} = V_{GS}$, $I_D = 4.3\text{ mA}$
$R_{DS(on)}$	Drain-Source On-state Resistance	-	5.5	7	$\text{m}\Omega$	$V_{GS} = 5\text{ V}$, $I_D = 16\text{ A}$
V_{SD}	Source-Drain Forward Voltage	-	1.4	-	V	$I_S = 0.5\text{ A}$, $V_{GS} = 0\text{ V}$

INN100W070A

100V Enhancement-mode GaN Power Transistor

Table 7 Dynamic characteristics

SYMBOL	PARAMETER	MIN	TYP	MAX	UNIT	TEST CONDITIONS
C _{ISS}	Input Capacitance	-	485	-	pF	V _{GS} = 0 V, V _{DS} = 50 V
C _{OSS}	Output Capacitance	-	220	-		V _{GS} = 0 V, V _{DS} = 50 V
C _{RSS}	Reverse Transfer Capacitance	-	3.5	-		V _{GS} = 0 V, V _{DS} = 50 V
C _{OSS(ER)}	Energy Related C _{OSS}	-	340	-		V _{GS} = 0 V, V _{DS} = 0 V to 50 V
C _{OSS(TR)}	Time Related C _{OSS}	-	500	-		V _{GS} = 0 V, V _{DS} = 0 V to 50 V
R _G	Gate resistance	-	2.1	-	Ω	
Q _G	Total Gate Charge	-	4.5	-	nC	V _{GS} = 5 V, V _{DS} = 0 V to 50 V, I _D = 16 A
Q _{GS}	Gate to Source Charge	-	1	-		V _{GS} = 5 V, V _{DS} = 0 V to 50 V, I _D = 16 A
Q _{GD}	Gate to Drain Charge	-	0.8	-		V _{GS} = 5 V, V _{DS} = 0 V to 50 V, I _D = 16 A
Q _{G(TH)}	Gate Charge at Threshold	-	0.6	-		V _{GS} = 5 V, V _{DS} = 0 V to 50 V, I _D = 16 A
Q _{OSS}	Output Charge	-	25	-		V _{GS} = 0 V, V _{DS} = 0 V to 50 V

9. Electric characteristics diagrams

at $T_J = 25^\circ\text{C}$ unless otherwise specified.

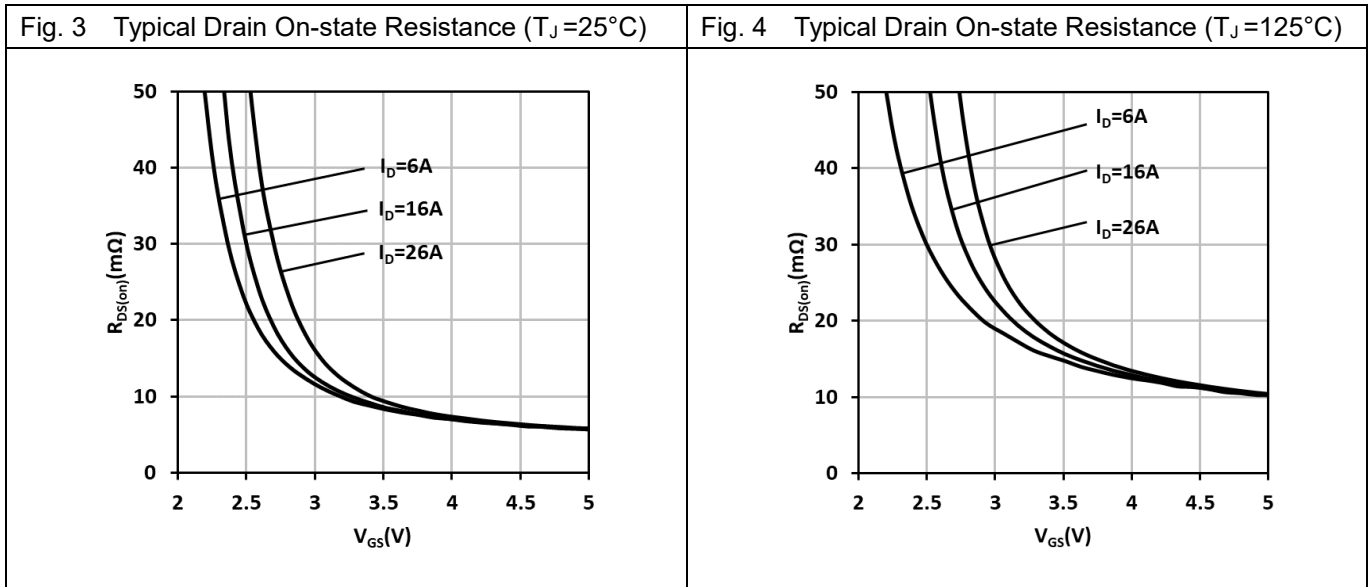
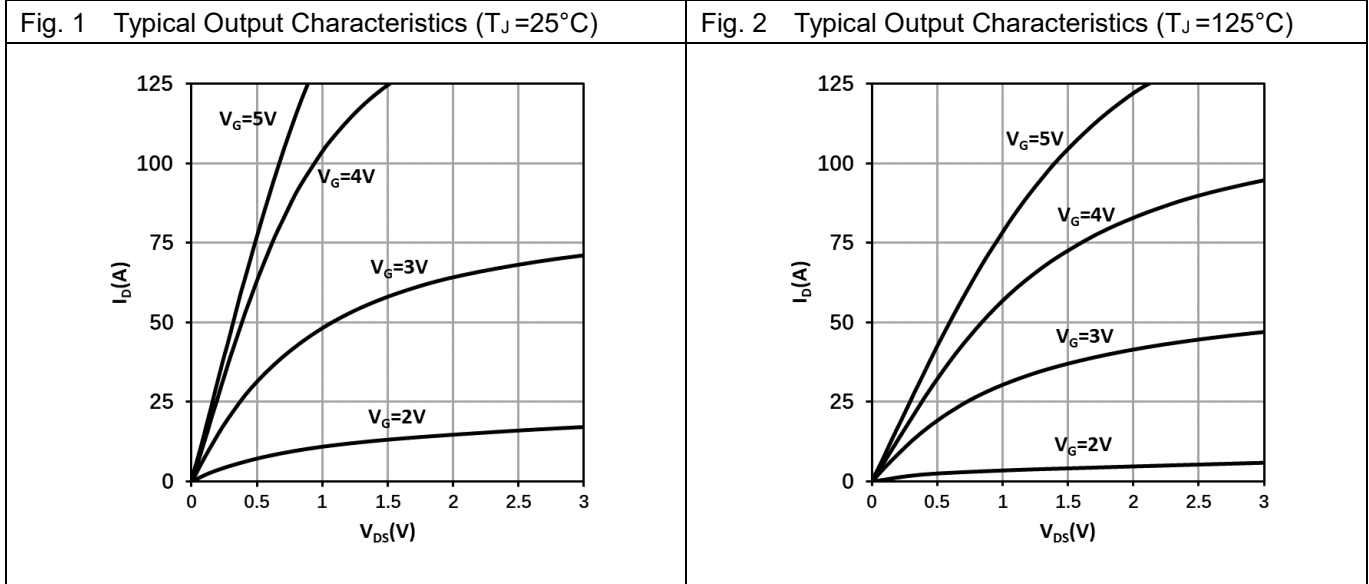

Fig. 5 Normalized On-State Resistance vs. Temp.

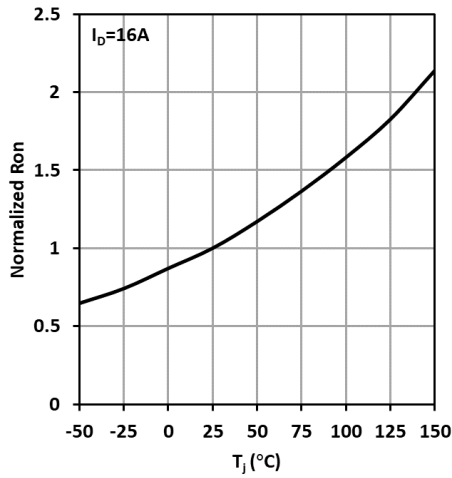

Fig. 6 Typical Transfer Characteristics

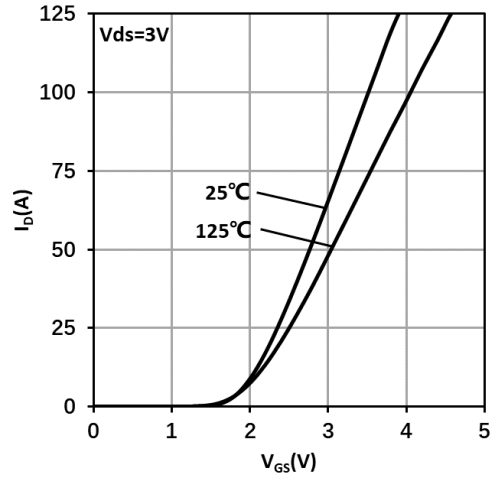

Fig. 7 Typ. Reverse Drain-Source Characteristics (VGS ≤ 0, Tj = 25°C)

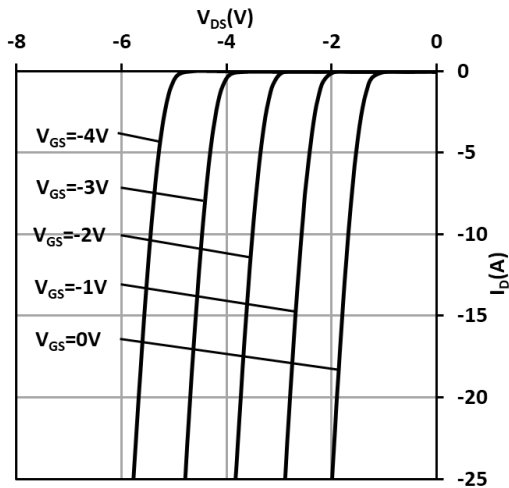

Fig. 8 Typ. Reverse Drain-Source Characteristics (VGS ≥ 0, Tj = 25°C)

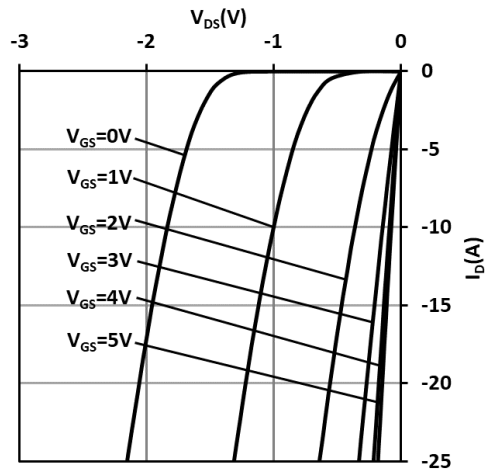

Fig. 9 Typ. Reverse Drain-Source Characteristics ($V_{GS} \leq 0$, $T_J = 125^\circ\text{C}$)

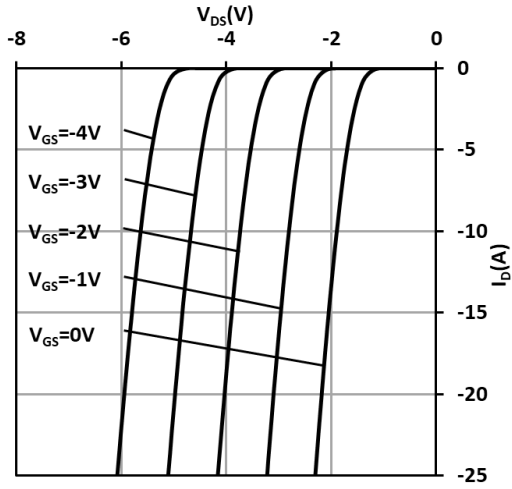

Fig. 10 Typ. Reverse Drain-Source Characteristics ($V_{GS} \geq 0$, $T_J = 125^\circ\text{C}$)

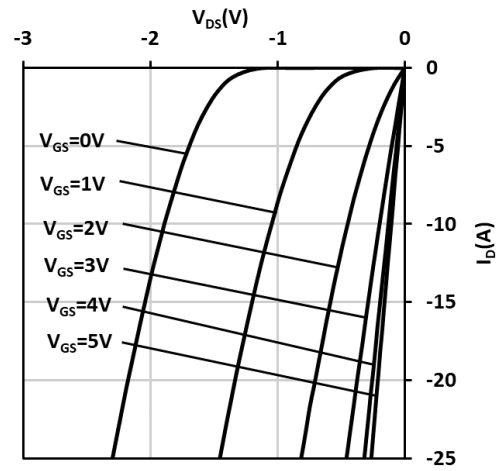

Fig. 11 Typ. Capacitances Characteristics

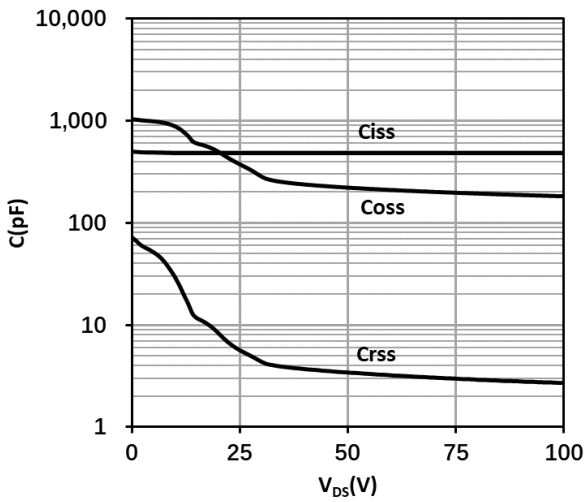

Fig. 12 Typ. Gate Charge

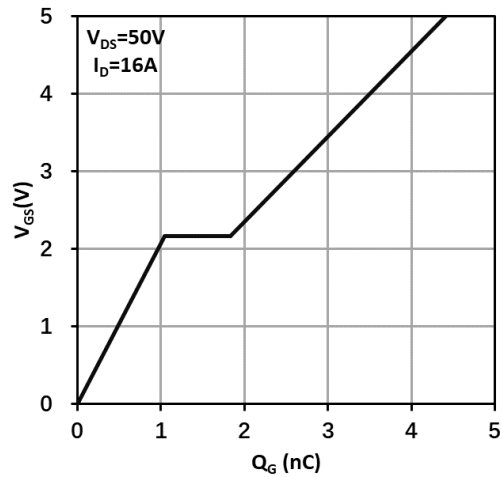

Fig. 13 Normalized Threshold Voltage vs. Temp.

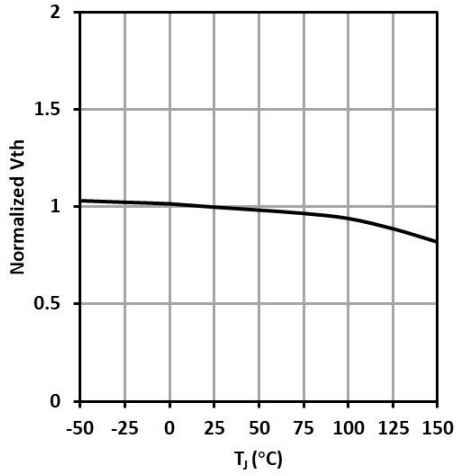

Fig. 14 Output Charge

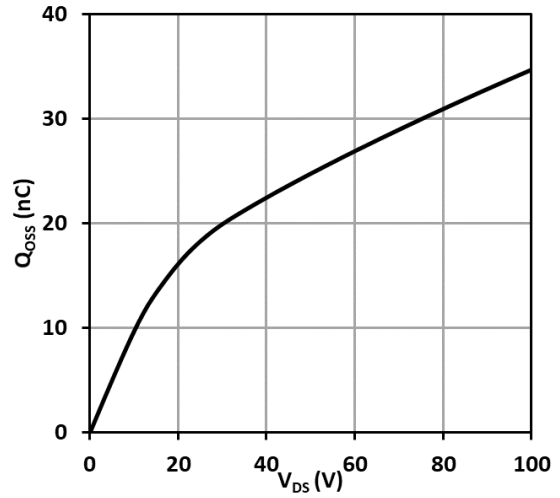

Fig. 15 Output Capacitance Stored Energy

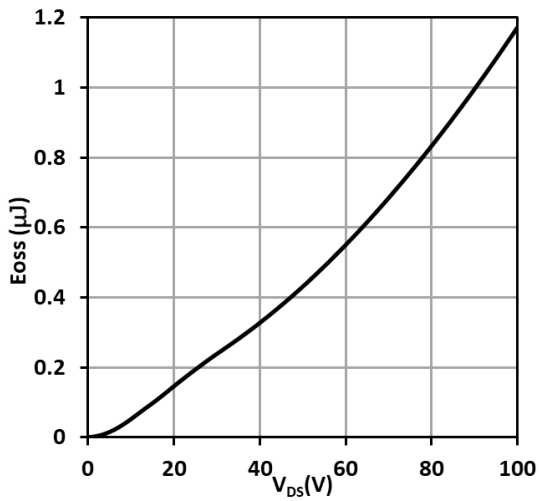

Fig. 16 Power Dissipation

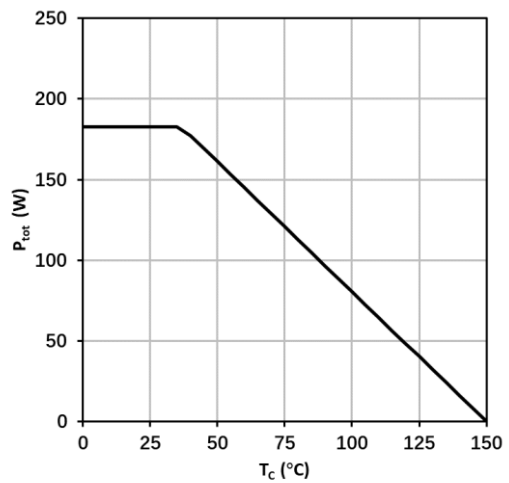

Fig. 17 Safe Operating Area

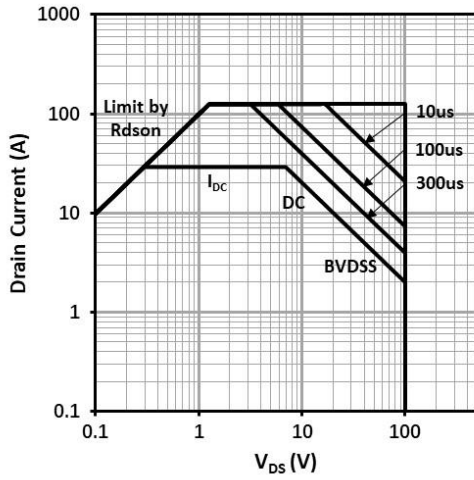
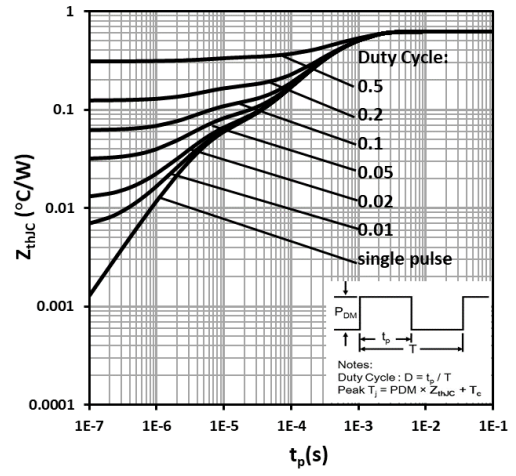

Fig. 18 Max. Transient Thermal Impedance



INN100W070A

100V Enhancement-mode GaN Power Transistor

10. Package outlines

Package Reference

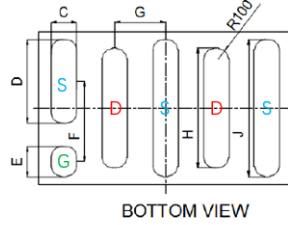
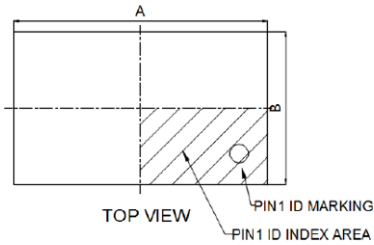

SYMBOL	MILLIMETER			NOTE
	MIN	NOM	MAX	
A	2.475	2.5	2.525	
B	1.475	1.5	1.525	
C	0.23	0.25	0.27	6X
D	0.805	0.825	0.845	
E	0.28	0.3	0.32	
F	0.7875 BASIC			
G	0.5 BASIC			
H	1.155	1.175	1.195	2X
J	1.33	1.35	1.37	2X
K	0.1	0.12	0.14	
L	0.395	0.43	0.465	

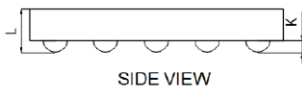

NOTE:

- 1) ALL DIMENSION ARE IN MILLIMETERS.
- 2) BOTTOM VIEW IS SOLDER BAR VIEW.
- 3) COMPLIES WITH JEDEC MO-211.
- 4) DRAWING IS NOT TO SCALE.
- 5) A,B IS PACKAGE SIZE
- 6) BAR COPLANARITY SHALL BE 0.05 MILLIMETERS MAX

Marking Reference:

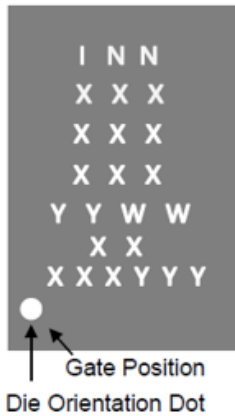

Row	Description	Example
Row1	Company name	INN
Row2	Product code	XXX
Row3	Lot Code	XXX
Row4		XXX
Row5	Date code	YYWW
Row6	Wafer ID	XX
Row7	Location ID	XXXYYY

11. Reel information

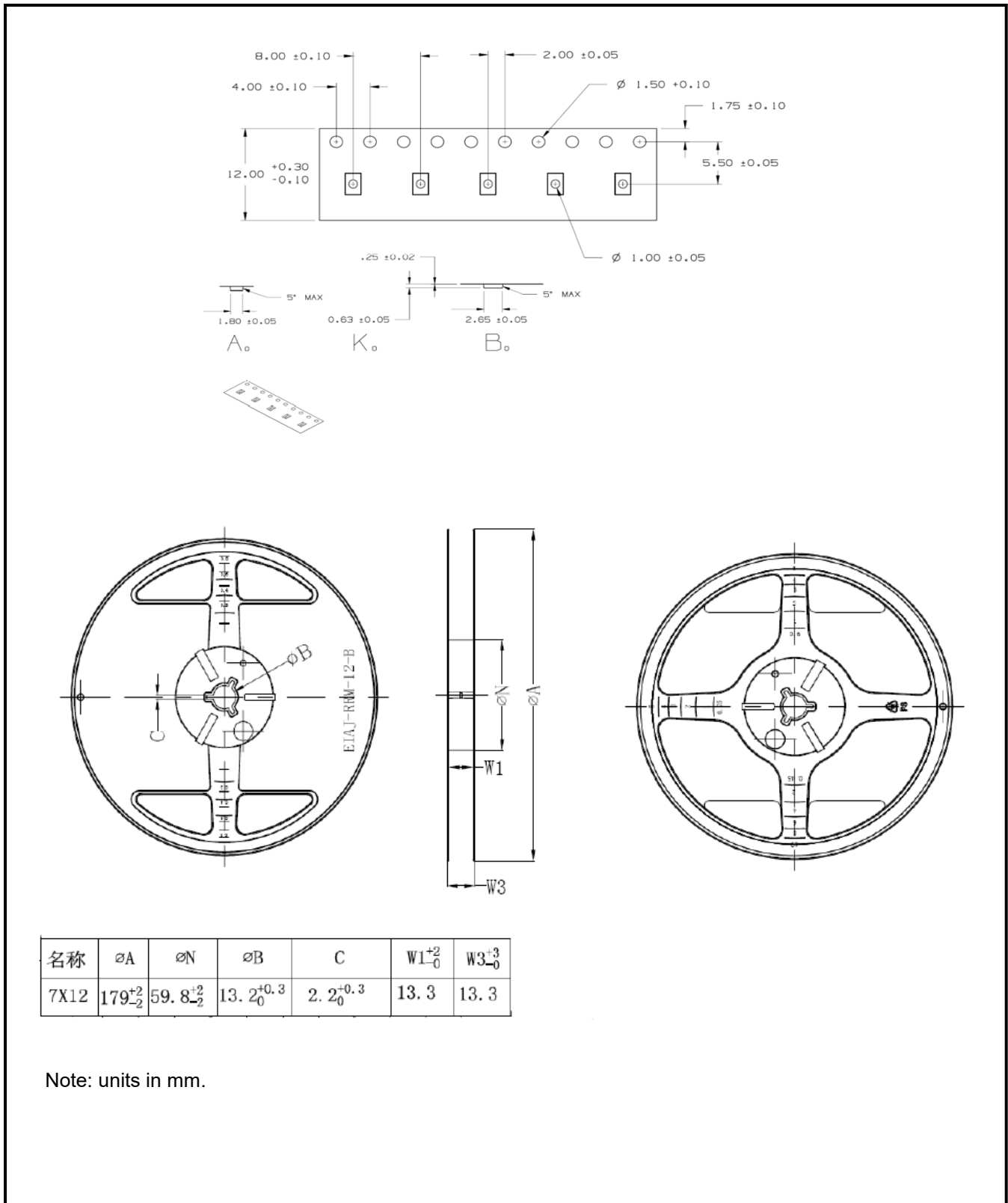

12. Land Pattern

Recommended Land Pattern

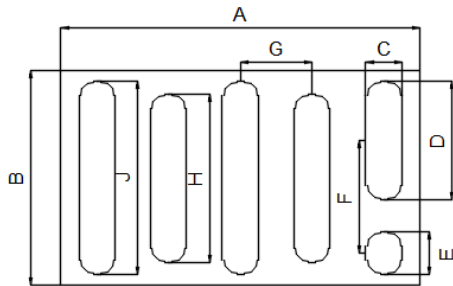

TOP VIEW

SYMBOL	NOM
A	2.50
B	1.50
C	0.23
D	0.805
E	0.28
F	0.7875
G	0.50
H	1.155
J	1.33

NOTE:

- 1)LAND PATTERN IS SOLDER MASK DEFINED.
- 2)IT IS RECOMENDED TO HAVE ON-CU TRACE PCB VIAS.

13. Revision history

Major changes since the last revision

Revision	Date	Description of changes
1.0	2022-12-12	1.0 version setup
1.1	2023-03-21	1.1 version setup, update the leakage value in table 6
1.2	2023-12-15	1.2 version setup, change product code from J19 to J17

Important Notice

The information provided in this document is intended as a guide only and shall not in any event be regarded as a guarantee of conditions, characteristics or performance. Innoscience does not assume any liability arising out of the application or use of any product described herein, including but not limited to any personal injury, death, or property or environmental damage. No licenses, patent rights, or any other intellectual property rights is granted or conveyed. Innoscience reserves the right to modify without notice. All rights reserved.